

**SWR**  
STEEL WIRE ROPE

**WIRE ROPE SOLUTIONS**





## ABOUT STEEL WIRE ROPE

With a proud pedigree spanning 30 years, we source, design, and produce quality-assured steel wire rope solutions.

We work with customers across all major sectors - from architects and engineers to project managers. This ensures the best possible outcome for your project at the best possible price.

Because when it comes to steel wire rope, for quality, expertise, service, and supply...

## WE GO BEYOND

### WE SERVE THE FOLLOWING INDUSTRIES:

- Marine
- Outdoor adventure & leisure
- Fall arrest & height safety
- Health & fitness machines
- Construction
- Defence
- Engineering & manufacturing
- Vehicle recovery
- Blinds & shade sails
- Theatre
- Lighting
- Pest control
- Interior design

# WIRE ROPE ASSEMBLIES

From our facilities in the UK, we design, manufacture, and supply wire rope assemblies in both stainless steel and galvanised material.

Our team are experts at adding value. Whether you need assemblies set to precise tolerances, accurate lead times or carefully managed delivery schedules, we take the stress out of every stage of your project - regardless of your location.

In addition, we can stamp, test, and certify assemblies to guarantee the safety and traceability of your order.

1. **Manufactured in domestic facilities**
2. **Assemblies fully stamped & tested**
3. **Supplied to all major industries**
4. **BS EN standards compliant**
5. **Supplied with official certification**
6. **Global delivery service**

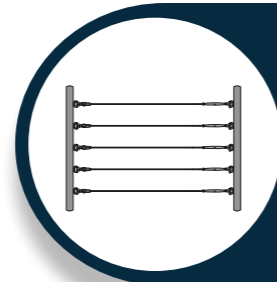

**BALUSTRADE  
INFILL/  
TENSION KITS**



**MARINE**



**ZIP LINES**

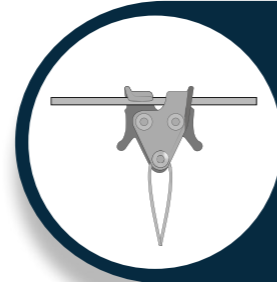

**CATENARY**



**CONSTRUCTION  
/ARCHITECTURE**



**WINCH ROPES**





EYE BOLTS  
& EYENUTS

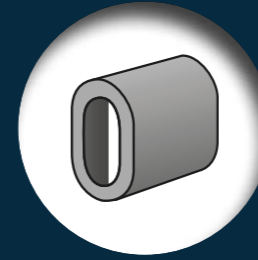

FERRULES



HOOKS



SHACKLES



TURNBUCKLES

## WIRE ROPE FITTINGS

We stock an extensive range of AISI 316 stainless steel and galvanised fittings. We supply a certificate of conformance to guarantee excellent durability under the harshest of environmental conditions.

Do you need a bespoke fitting? Send us a drawing and we will manufacture a sample for approval before large-scale production takes place.

1. Large UK stockholding
2. All fittings tested & certified
3. Full design & sample service
4. Global delivery service

OFFICIAL SUPPLIERS FOR:



RIGGING  
SCREWS &  
COMPONENTS



SWAGE /  
SWAGELESS  
TERMINALS



SOCKETS



THIMBLES



WIRE ROPE  
GRIPS

# STEEL WIRE ROPE

We have supplied steel wire rope to companies around the world since our doors first opened in 1989.

With our large UK stockholding and network of global partners, we can source galvanised or stainless-steel wire rope in any size you require. Also, we supply ropes with certification in bulk reels or broken down by lengths.

Long-term customers continue to use our services due to a “hands-on” approach. Our team is committed to getting the job done, regardless of the size of your order or tight deadlines.

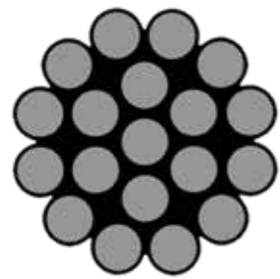

1x19



7x7

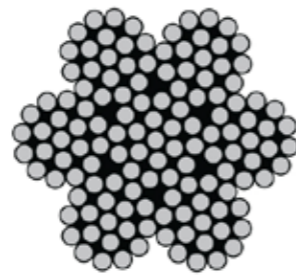

7x19

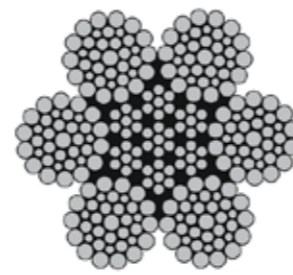

6x36 IWRC

[MORE SPECIFICATIONS AVAILABLE](#)



## TEST CERTIFICATION

We have our own testing facilities and provide loading and destruction tests on request. All certified with full traceability in line with our ISO9001 procedures.



## IN STOCK

Large range of stainless steel and galvanised wire rope. Ready to be picked, packed, and delivered.



## FAST DELIVERY

We offer quick delivery on all items from stock. With a range of courier options to suit you.





## BESPOKE ASSEMBLIES

Looking for a unique wire rope assembly or to improve an existing application? We can design and manufacture any solution you require.

Market leaders in a range of industries use our services to provide bespoke assemblies for different applications. From the defence sector to stone excavation, we understand the importance of what the end user wants to achieve.



AUTOMOTIVE

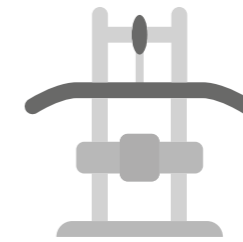

GYM CABLES



SWIMMING POOLS

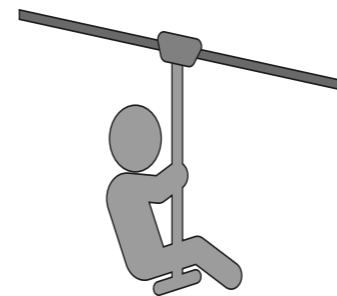

ZIP LINES



BALUSTRADES



THEATRE RIGGING

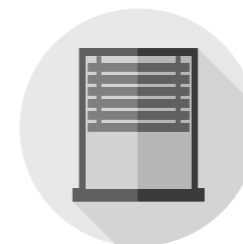

BLINDS

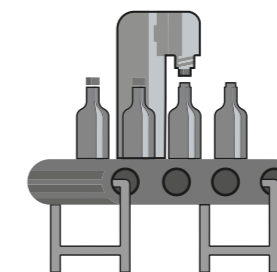

CONVEYOR BELTS



# COATED WIRE ROPES

Many applications need coated ropes to aid performance and durability. We offer a wide range of coatings, including Polyvinyl Chloride (PVC), Polypropylene (PP) and Nylon.

Large stockholding and range of colours available.

## AVAILABLE COATINGS

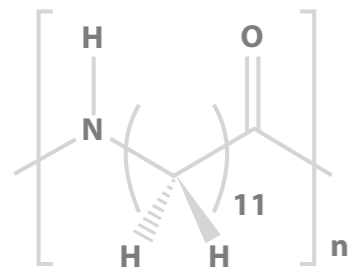

NYLON - 11

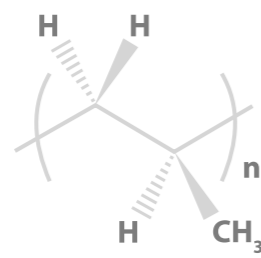

POLYPROPYLENE

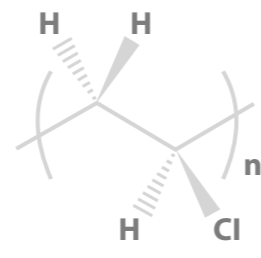

PVC

## AVAILABLE COLOURS

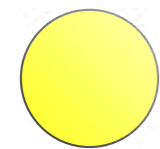

HIGH-VIS. YELLOW



HIGH-VIS. GREEN

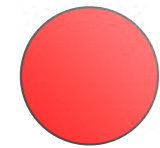

HIGH-VIS. RED

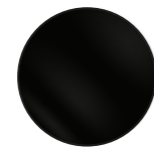

BLACK

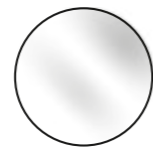

WHITE

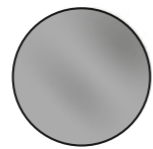

GREY

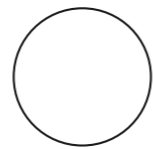

CLEAR

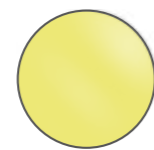

YELLOW



LIME



GREEN

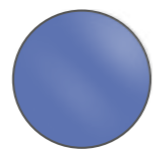

BLUE

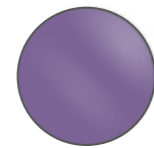

PURPLE

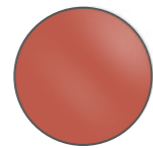

RED

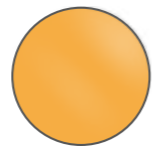

ORANGE





# WINCH ROPES

We supply winch ropes to the exact length and in accordance with relevant BS EN standards. All of our winch ropes are stamped with a working load limit and batch details for easy traceability and identification. Full safety certification is provided with every order.

We have customers in a range of diverse sectors and remain a market leader in winch cables.

## End A Terminations



SOFT EYE ONLY



THIMBLE EYE ONLY



SOFT EYE & LARGE EYE SAFETY HOOK



SOFT EYE & SWIVEL SAFETY HOOK



SOFT EYE & SWIVEL SELF-LOCKING HOOK

## End B Terminations



FUSED & TAPERED

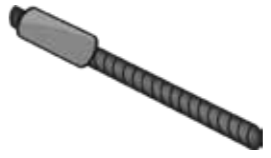

END STOP



UNFINISHED

## Wire Rope

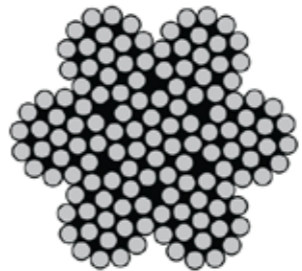

7x19

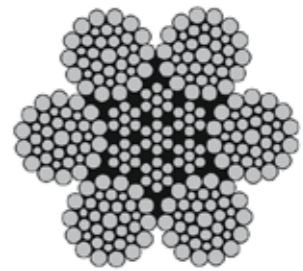

6x36 IWRC



# FALL ARREST ACCESSORIES

SWR have worked with fall-arrest installers in the supply of high-quality, stainless-steel wire rope and components for over 30 years.

Whether you are installing horizontal or vertical systems, SWR have a wide range of products available to assist with your requirements. With years of knowledge, our team can supply everything from wire rope through to individual and bespoke fittings used in these systems. Some of our main components are listed below.

If your company needs steel wire rope and fittings for Fall Arrest Systems, please contact us today for a no obligation quote.

## FITTINGS FOR FALL ARREST

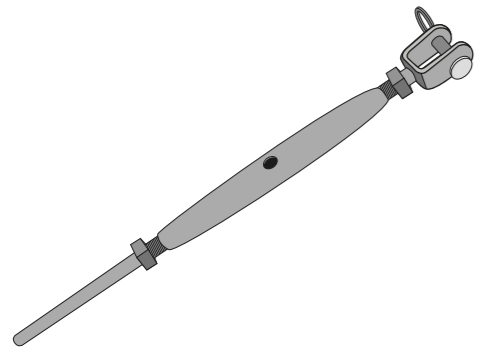

**FORK AND SWAGE RIGGING SCREW**

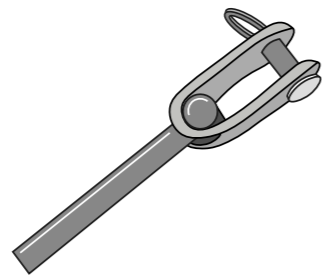

**SWAGE TOGGLE TERMINAL**

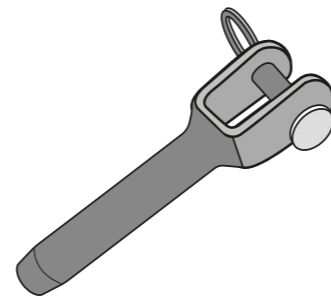

**SWAGE FORK TERMINAL**

## WIRE ROPES FOR FALL ARREST

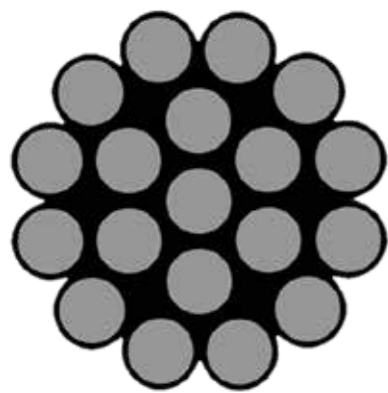

**1x19 STAINLESS STEEL WIRE ROPE**

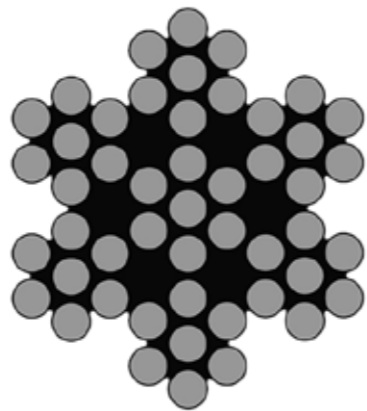

**7x7 STAINLESS STEEL WIRE ROPE**

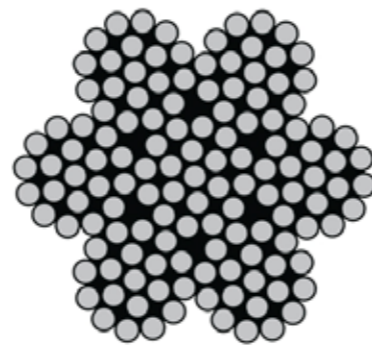

**7x19 STAINLESS STEEL WIRE ROPE**

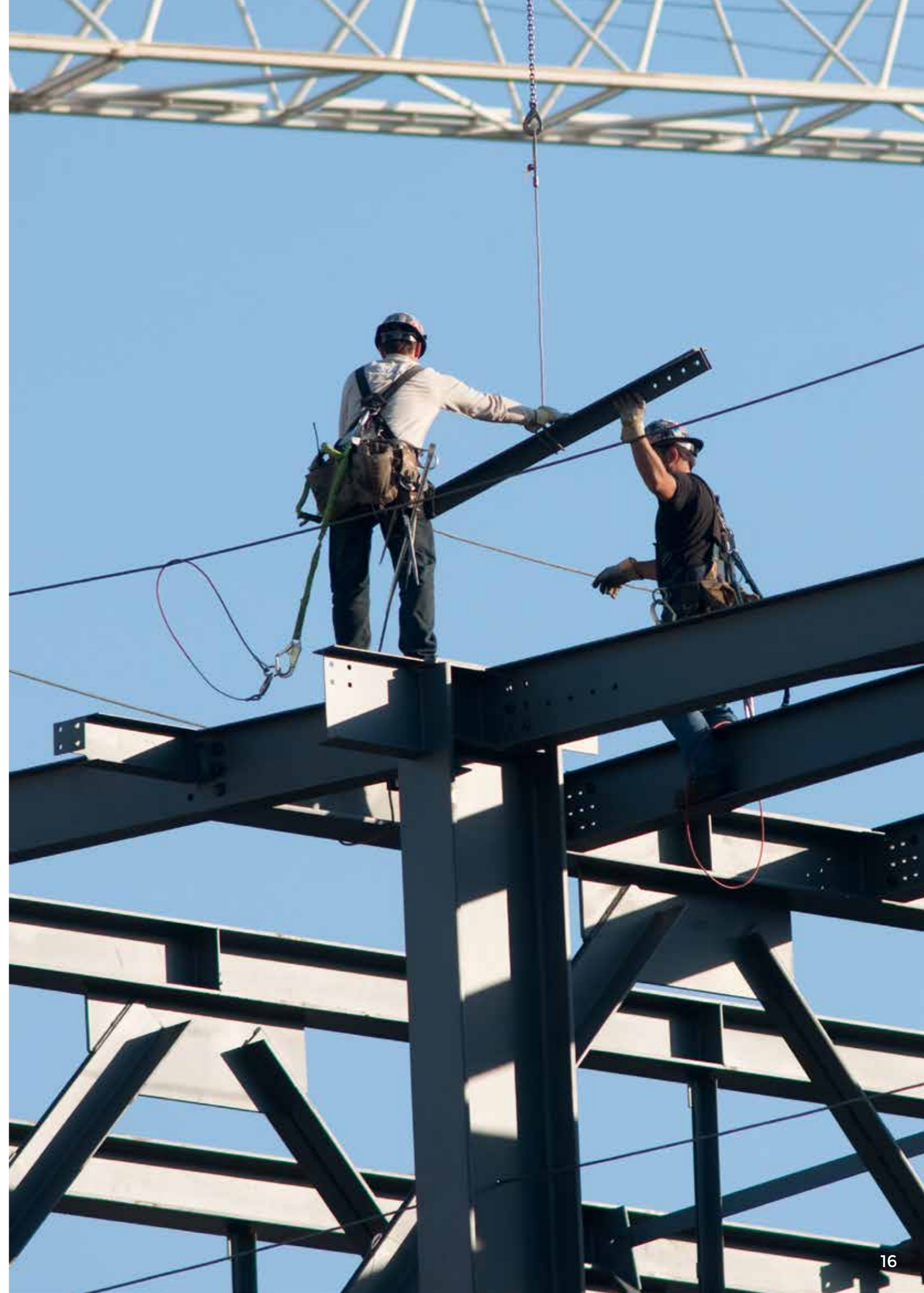



# ADVENTURE ROPE SOLUTIONS

Whether it's a garden zip wire or large commercial project, we offer a complete product and services package. This includes providing materials for a range of applications such as zip wires, high rope courses and playgrounds.

We work alongside leading specialists of adventure rope accessories to help bring your vision to life - sourcing, designing, and producing a solution, however challenging the project.

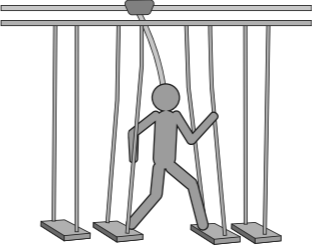

HIGH ROPE COURSES



ZIP WIRES

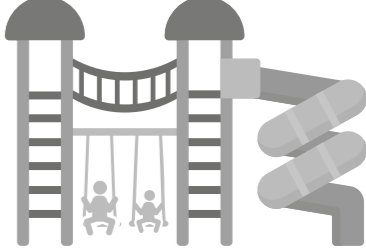

PLAYGROUNDS

## FITTINGS

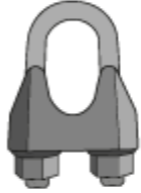

DIN-1142 Wire Rope Grips



Galvanised Commercial Thimbles



Jaw and Jaw - Tested Turnbuckles

## WIRE ROPES

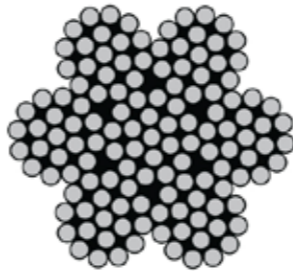

7x19 Galvanised Wire Rope

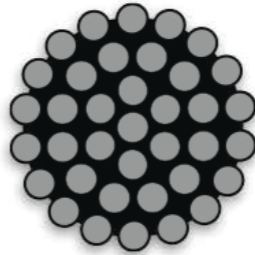

1x37 Galvanised Wire Rope

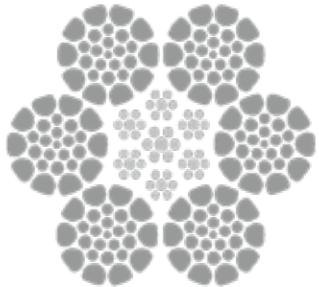

6xK26WS Galvanised Wire Rope

# WHIPBLOCKS

Supplied with straightforward instructions, the whip block system is not reliant on springs, ensuring a strong, firm, long lasting grip. The whip block is coated in Kevlar/Polyester with a patented loop choke system to withstand the most powerful of hoses. Fully tested and compliant to all EU regulations. Demonstrative videos are available online.

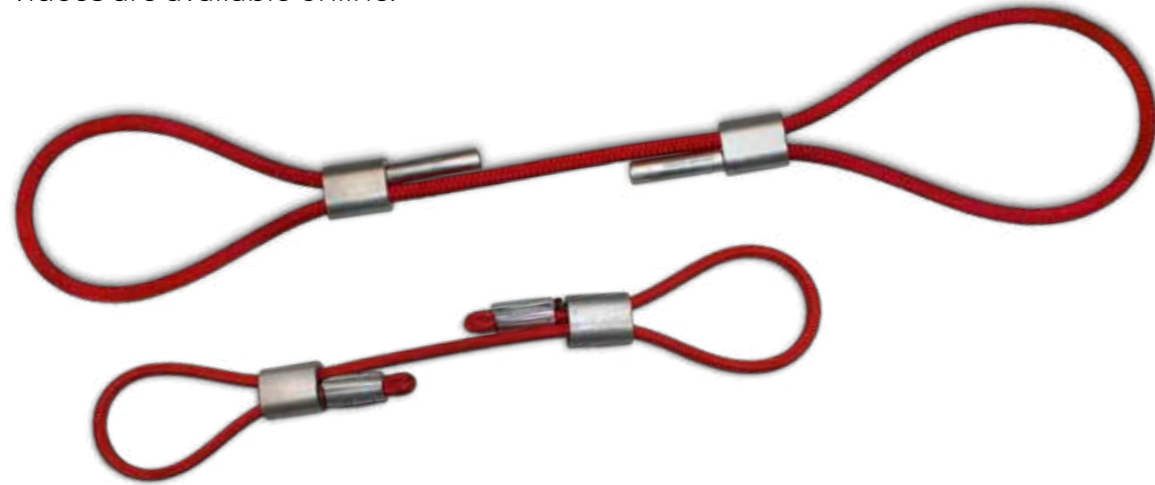

- Manufactured to Bureau Veritas Standards in Italy
- Patented Choke System ensures a strong, firm, long-lasting grip
- Easy to handle, install, adjust and tighten (supplied with installation instructions)
- Choke tightens under pressure and not reliant on spring wear and tear
- Less abrasive to hose than traditional Whipchecks
- Kevlar/Polyester coating reduces potential fragmentation if overloaded
- Consistent high breaking load performance
- Individual identification and full batch traceability
- Bureau Veritas certified and destruction tested in the UK
- Suitable for use in explosive atmospheres (ATEX)
- CE Marked



OIL AND GAS



HYDRAULIC AIR



WATER

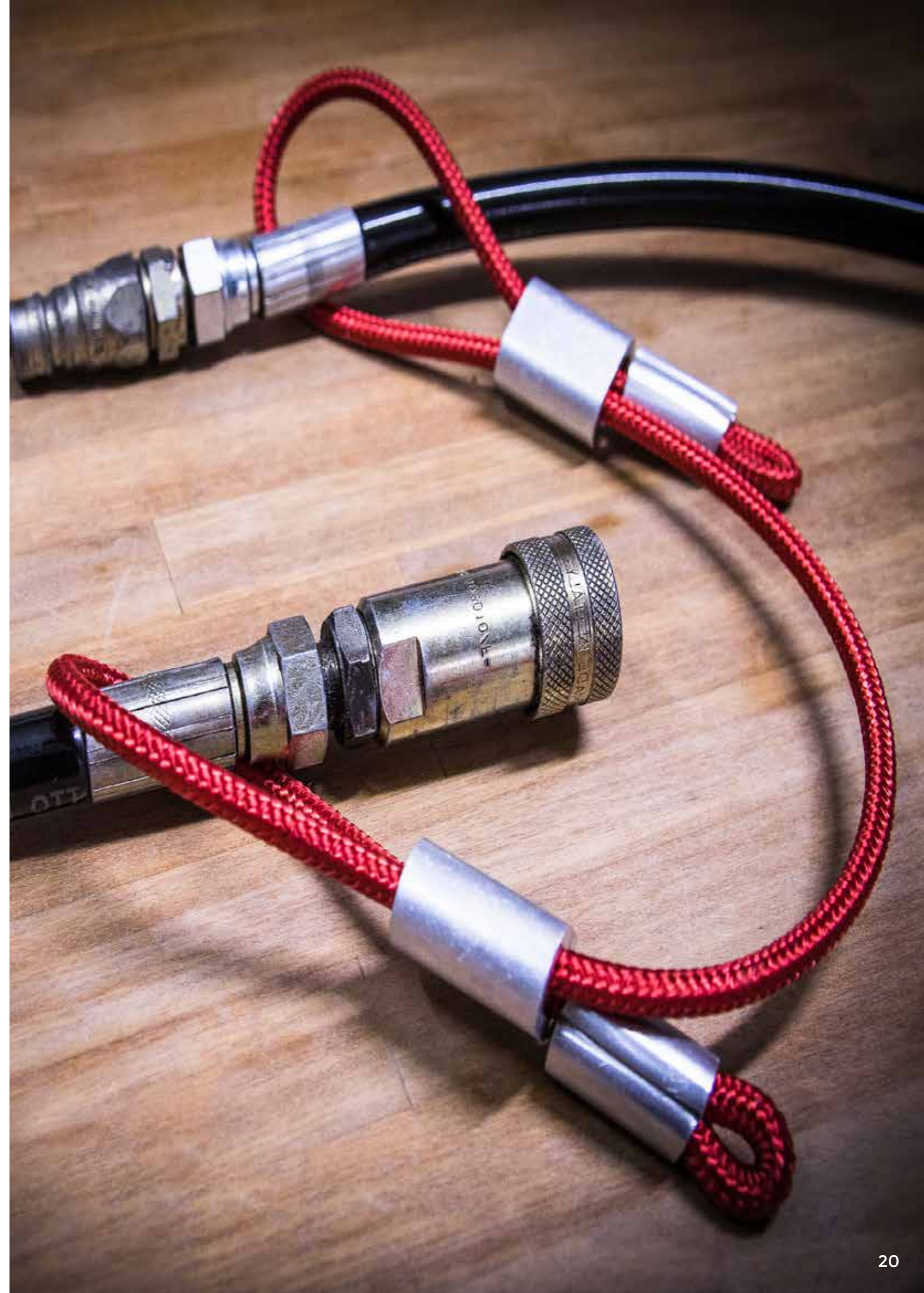



## WHIPCHECKS

Designed and produced to ensure the safety of operatives, the Whipcheck safety cable will fulfil its purpose should the hosing ever detach from its station. Industries include Oil & Gas, Water and Hydraulic hosing. Available in different sizes, materials and designs.



- Manufactured from high grade galvanised steel
- Other materials available on request for special applications
- The galvanised steel cable prevents hose whip with easily fitted spring loaded loops
- Available in two sizes although bespoke sizes are available on request
- Low cost answer to eliminate injuries caused by broken air hose connections
- No tools required meaning easy installation and removal



OIL AND GAS

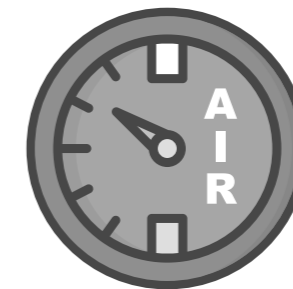

HYDRAULIC AIR



WATER

## BESPOKE ENGINEERED COMPONENTS

We specialise in sourcing and supplying engineered components for major industries. Over 30 years in business means we have built up a network of trusted partners (both at home and overseas) to source bespoke parts in a range of materials.

We collaborate closely with you during the design and prototyping stages to find cost-effective solutions without compromising on quality. In fact, using our services could save you up to 40% compared to other companies.

All components are produced in accredited facilities with established supply chains.



DESIGN SERVICE



PROTOTYPING



MACHINED PARTS



DIE CASTING & FORGING



PRESSED PARTS



TURNED PARTS



## REELING MACHINES

Our reeling machines boast numerous specifications to help reduce working time and increase productivity. They are available in standard models with 200kg and 500kg reeling capacities. Also, based on your requirements, we can change the height, weight, shape of the steel framework and even add additional features. From heavy-duty stationary models to compact mobile versions for workspaces, we can build the perfect machine for your circumstances.

Our reeling machines are also stringently tested at every stage of production to meet high standards of safety and efficiency.



## FEATURES

- Machine framework can be fully customised
- Speed controlled
- Controlled start and stop
- Full reversing facility
- Traversing by hand via measuring head
- Single phase supply required
- Emergency stop
- Rigid steel structure
- Wide range of reels can be used
- Measuring clock
- 12 months parts warranty
- Additional features required can be reviewed upon request

## TOOLS & MACHINERY

We supply a wide range of steel wire rope tools and equipment. For more information on any of the products below, please contact us and we will be happy to assist.



## GREENWALL SYSTEMS

We manufacture SWR Greenwall Systems using our high quality AISI 316 marine grade stainless steel and fittings. Designed to transform fascia, external walls, fences and other surfaces into a modern and thriving green wall. Combining practical straightforward installation with a high quality product, this kit comes in pre-defined sizes, ready for immediate use.

Contact us for large-scale or domestic projects.

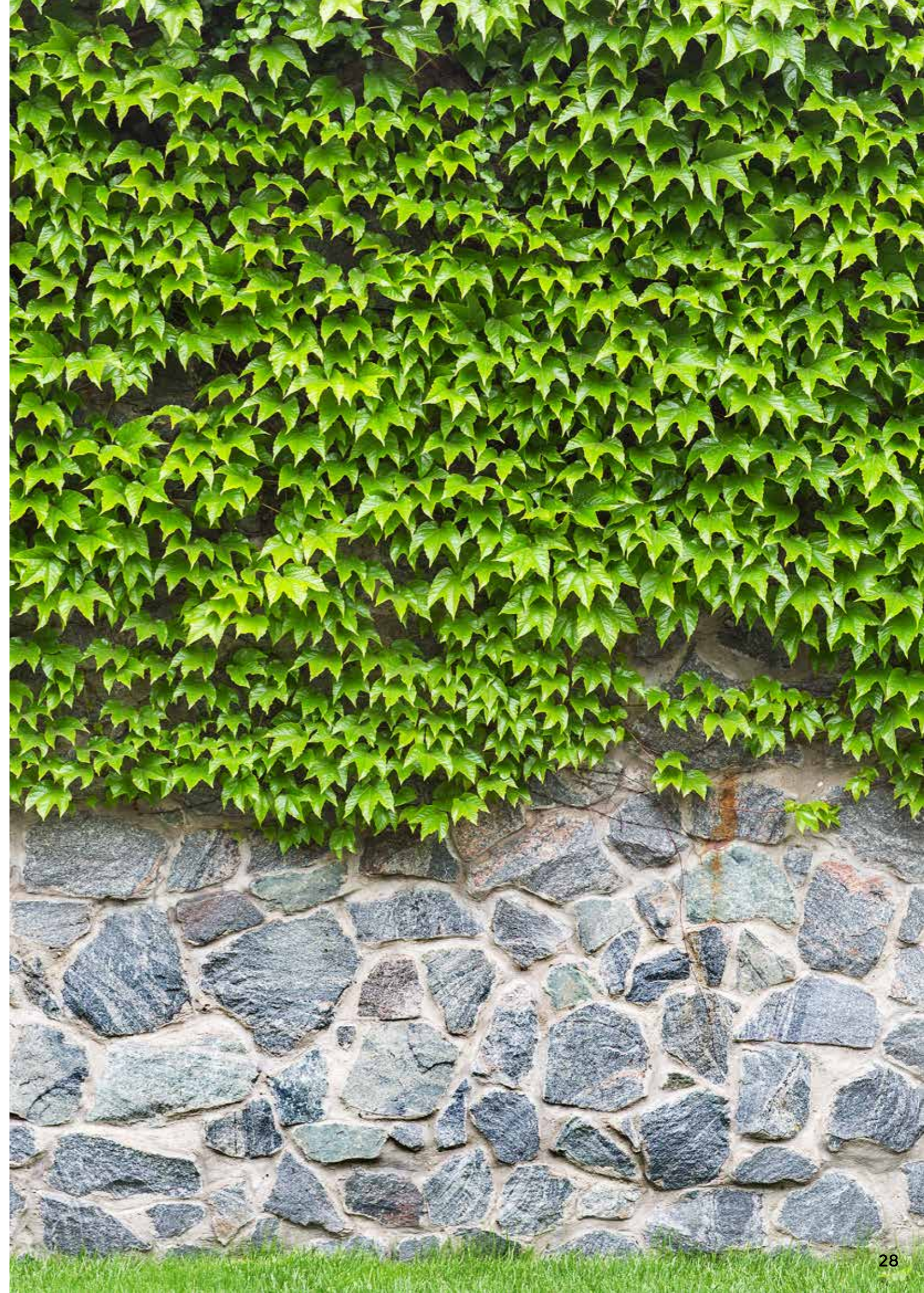



## PRACTICAL INFORMATION



### ADDRESS

Unit 2-4, Eastman Way  
Hemel Hempstead  
Hertfordshire  
HP2 7DU



### OPENING TIMES

Monday - Friday 08:30 - 17:00



### WEBSITES

[www.steelwirerope.com](http://www.steelwirerope.com)  
[www.swrgroup.com](http://www.swrgroup.com)



### ORDER BY PHONE

Speak to a member of our highly trained customer service team by contacting us on **+44 (0)1442 353 005**



### ORDER BY EMAIL

If you would prefer to send us an email simply contact us at [sales@steelwirerope.com](mailto:sales@steelwirerope.com)

## SERVICES



### TECHNICAL ADVICE

Our dedicated Sales & Service team are on hand to offer support and technical advice, helping you to identify the best solutions for your application.



### SWR's PRODUCTION TEAM

Our fully trained team of engineers hand craft your cables to the highest standards and the tightest tolerances. All assemblies are manufactured in-house to your bespoke requirements.



### QUALITY ASSURED

All components are fully checked at various stages to ensure that our high quality standards are met.



### TEST CERTIFICATION

We have our own in-house testing facilities and can offer proof loading and destruction tests on request. All materials are certified and have full traceability in line with our ISO9001 procedures.



### IN STOCK

We stock a large range of stainless steel and galvanised wire ropes and fittings – ready to be picked, packed and dispatched.



### FAST DELIVERY

We can offer quick delivery on all items available from stock, with a range of courier options to suit your requirements.





Units 2 - 4 Eastman Way,  
Hemel Hempstead,  
Hertfordshire, HP2 7DU

 +44 (0)1442 353 005

 01442 259918

 [www.steelwirerope.com](http://www.steelwirerope.com)

 [sales@steelwirerope.com](mailto:sales@steelwirerope.com)